



Expanding Your Solutions

Corporate Headquarters
13191 Crossroads Pkwy N., Ste 325
City of Industry, CA 91746
Phone: 800.775.2362
Fax: 626.330.7598

Manufacturing Facilities
City of Industry, CA
Commerce City, CO
Ft. Worth, TX
Pittsburg, CA

Structural Engineering/Design
1001-A Pittsburgh Antioch Hwy
Pittsburg, CA 94565
Phone: 800.775.2362
Fax: 626.330.7598

Technical Services
13191 Crossroads Pkwy N., Ste 325
City of Industry, CA 91746
Phone: 800.416.2278
Fax: 626.249.5004

ANGLE – 3" x 3" x 54 mil.

Geometric Properties

3" x 3" 54-mil Angle is fabricated from hot-dipped galvanized steel in standard G60 coating. A G90 coating is available upon special request and may require extended lead time and up-charges.

Properties: 3" x 3" x 54 mil.

Product Code	Thickness (T)		Yield (ksi)	X (in)	Y (in)
	Design Thickness (in)	Minimum Thickness (in)			
16A33	0.0566	0.0538	50	3	3

Notes:

1. Uncoated steel thickness. Thickness is for carbon sheet steel.
2. Minimum thickness represents 95% of the design thickness and is the minimum acceptable thickness.

Color Code (painted on ends):

54-mil: Green

ASTM & Code Standards:

- ASTM A653/653M, A924/A924M, A1003/A1003M, C754, C954
- IBC: 2015, 2018, 2021
- CBC: 2016, 2019, 2022
- AISI: S100, S200, S240

LEED v4.1 – BD & C: Building Design and Construction – Materials and Resources

Building Life Cycle Impact Reduction (up to 4 points)

- Option 3: Building and Material Reuse
- 2 points for 25% reuse, 3 points for 50% reuse, 4 points for 75% reuse

Building Product Disclosure and Optimization – Environmental Product Declarations (up to 2 points)

- Option 1: Environmental Product Declaration (EPD)
- Option 2: Industry-wide EPD for cold-formed steel

Building Product Disclosure and Optimization – Sourcing of Raw Materials (up to 2 points)

- Option 1: Leadership Extraction Practices
- Option 2: Points based on recycled content of CFS products
- Construction and Demolition Waste Management (up to 2 points)
- 1 point for 50% waste diversion, 2 points for 75% waste diversion

CEMCO Cold-Formed Steel Framing Products Contain 30% to 37% Recycled Steel

- Total Recycled Content: 36.9%, Post-Consumer: 19.8%, Pre-Consumer: 14.4%

Can Be Used In:

- Framing Connections
- Corner Intersections
- Half-track Connections
- Truss Uplift

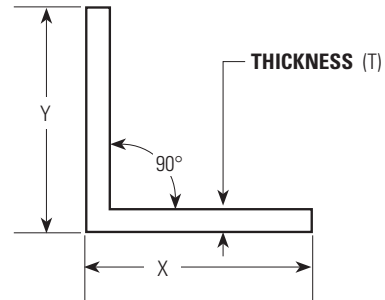
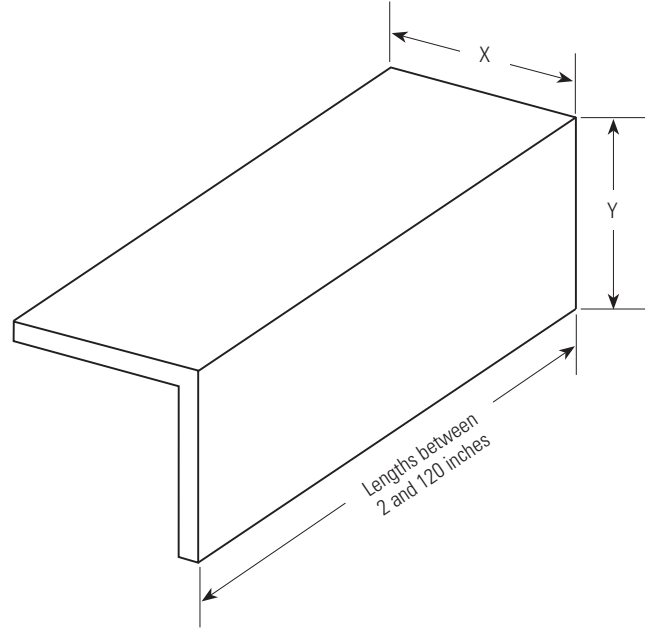

Technical Services

Technical Services: 800.416.2278
Structural Engineering/Design: 925.473.9340
www.cemcosteel.com



This technical information reflects the most current information available and supersedes any and all previous publications effective January 09, 2025.

01-09-2025 AT