



Expanding Your Solutions

Corporate Headquarters
13191 Crossroads Pkwy N., Ste 325
City of Industry, CA 91746
Phone: 800.775.2362
Fax: 626.330.7598

Manufacturing Facilities
City of Industry, CA
Denver, CO
Ft. Worth, TX
Pittsburg, CA

Structural Engineering/Design
1001-A Pittsburg Antioch Hwy
Pittsburg, CA 94565
Phone: 800.775.2362
Fax: 626.330.7598

Technical Services
13191 Crossroads Pkwy N., Ste 325
City of Industry, CA 91746
Phone: 800.416.2278
Fax: 626.249.5004

ANGLE – 3" x 3" x 33 mil.

Geometric Properties

3" x 3" 33-mil Angle is fabricated from hot-dipped galvanized steel in standard G40 coating. G60 and G90 coatings are available upon special request and may require extended lead time and up-charges.

Properties: 3" x 3" x 33 mil.

Product Code	Thickness (T)		Yield (ksi)	X (in)	Y (in)
	Design Thickness (in)	Minimum Thickness (in)			
20A33	0.0346	0.0329	33	3	3

Notes:

1. Uncoated steel thickness. Thickness is for carbon sheet steel.
2. Minimum thickness represents 95% of the design thickness and is the minimum acceptable thickness.

Color Code (painted on ends):

33-mil: White

ASTM & Code Standards:

- ASTM A653/653M, A924/A924M, A1003/A1003M, C954
- IBC: 2012, 2015, 2018
- CBC: 2013, 2016
- AISI: S100-07, S100-12, S100-16, S200-12, S240-15

LEED v4 for Building and Design Construction

- MR Prerequisite: Construction and Demolition Waste Management Planning.
- MR Credit: Construction and Demolition Waste Management.
- MR Credit: Building Product Disclosure and Optimization – Sourcing of Raw Materials, Option 2.
- MR Credit: Building Product Disclosure and Optimization – Environmental Product Declarations, Options 1 & 2.
- MR Credit: Building Product Disclosure and Optimization – Material Ingredients, Option 1.
- MR Credit: Building Life-Cycle Impact Reduction, Option 4.

CEMCO cold-formed steel framing products contain 30% to 37% recycled steel.

- Total Recycled Content: 36.9%
- Post-Consumer: 19.8%
- Pre-Consumer: 14.4%

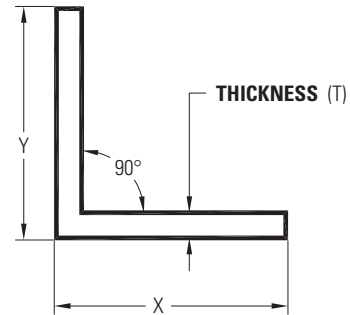
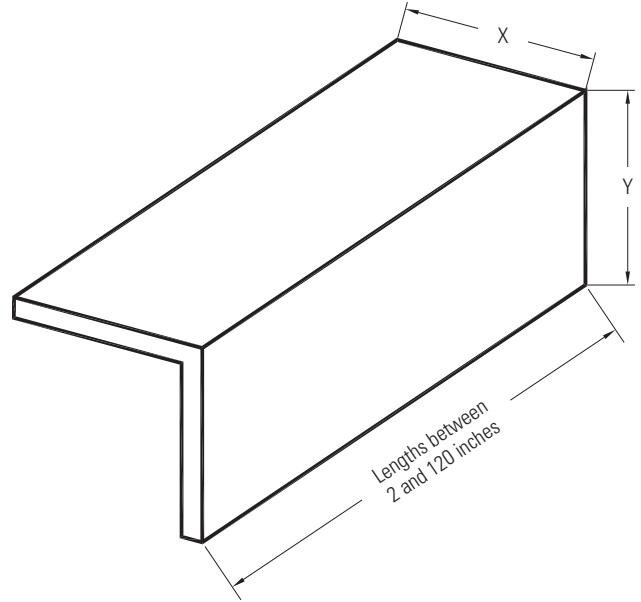

Technical Services

Technical Services: 800.416.2278
Structural Engineering/Design: 925.473.9340
www.cemcosteel.com



This technical information reflects the most current information available and supersedes any and all previous publications effective December 21, 2018.
12-21-18 AT